

Banded Wood Round Lazy Susans

Installation Instructions for the BLSR2xx Series



IMPORTANT:

Before you begin, make sure you familiarize yourself with all the parts and fully read the instructions.

CUSTOMER SERVICE:

Toll-free customer help line available weekdays between 7:00am and 6:00pm Central Time at 800-463-0660.

TOOLS NECESSARY:

Screw gun or Phillips screwdriver and tape measure. NOTE: If screw gun has a clutch, set to lowest setting so as not to over tighten and/or strip screws.

hardware
resources[®]

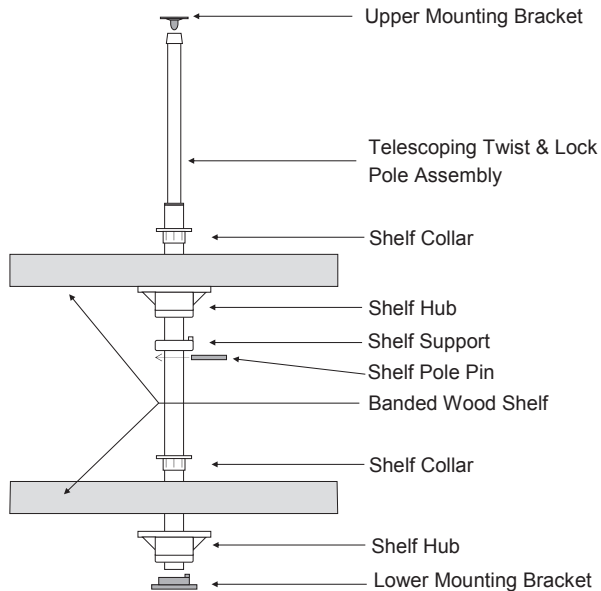

#8 x 5/8" Pan Head Phillips Wood Screw	8X
#6 x 1/2" Pan Head Phillips Wood Screw	4X per shelf
Telescoping Twist & Lock Pole Assembly	1X
Round Shelf	2X
Shelf Hub	2X
Shelf Collar	2X
Shelf Support	1X
Steel Pole Pin	1X
Lower Mounting Bracket	1X
Upper Mounting Bracket	1X

STEP 1

Measure and Mount Supports

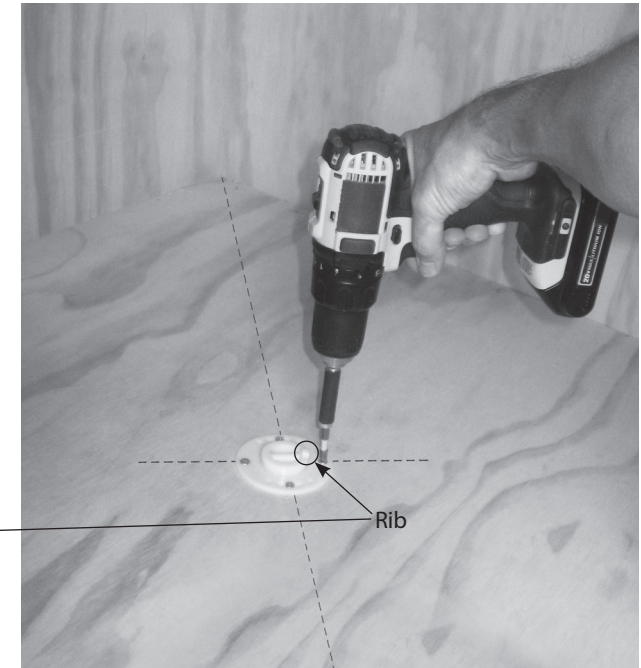
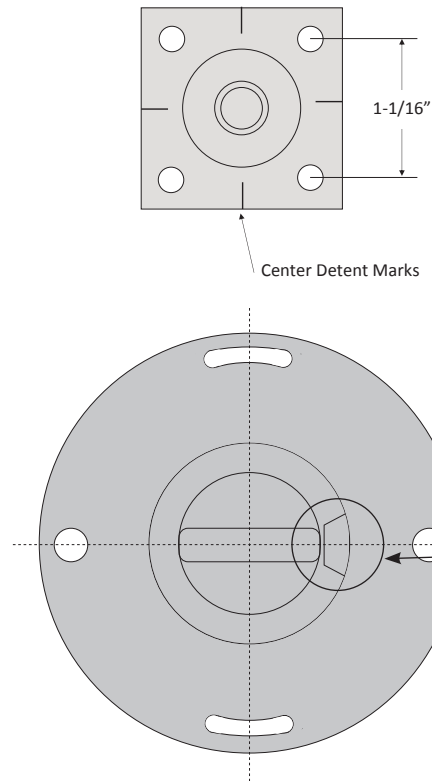

Mark layout for Lower Mounting Bracket by placing a shelf in the cabinet. Center the shelf on the bottom of the cabinet, making sure you have proper clearance from cabinet walls and door. Mark the mounting location by tracing around the hole in the middle of the shelf. Draw an "X" through the center of the circle as shown. Measure the center of the bottom mounting location and transfer to the top of the cabinet. Align Upper Mounting Bracket with center detent marks and install with four (4) - #8 x 5/8" Pan Head Phillips Wood Screws. Install Lower Mounting Bracket and secure with four (4) - #8 x 5/8" Pan Head Phillips Wood Screws to the bottom of the cabinet as shown.

STEP 2 - Install Hubs

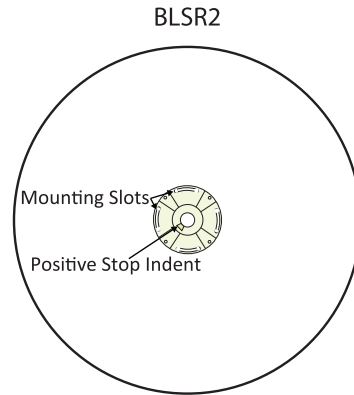
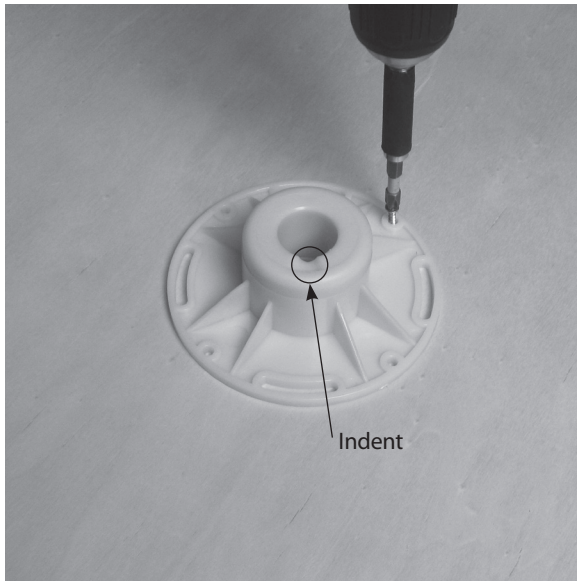

Turning a shelf upside down, attach the Shelf Hub with four (4) - #6 x 1/2" Pan Head Phillips Wood Screws in the center of the mounting slots as shown. Turning shelf back over push the Shelf Collar into the top of the shelf until flush. Repeat with second shelf.

STEP 3 - Shelf Assembly



From the bottom of the pole, slide one Shelf Assembly, the Shelf Support, and then the other Shelf Assembly onto the Pole Assembly. Slide bottom of Pole Assembly into the Lower Mounting Bracket.

STEP 4 - Pole Extension

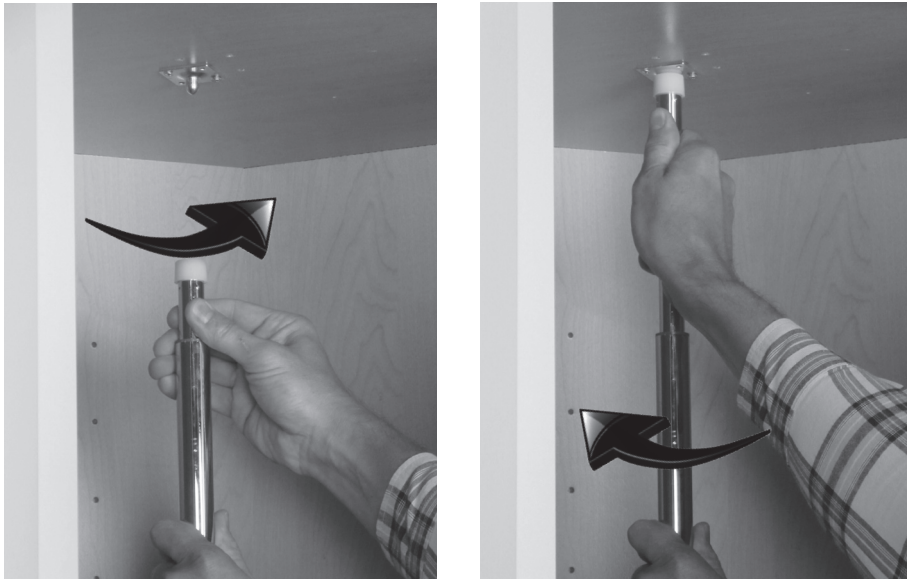

Holding onto the lower pole, twist the upper pole counter-clockwise to release. Extend pole upwards until it rests firmly against the Top Mounting Bracket and tighten by turning the upper pole clockwise.

STEP 5 - Shelf Adjustment

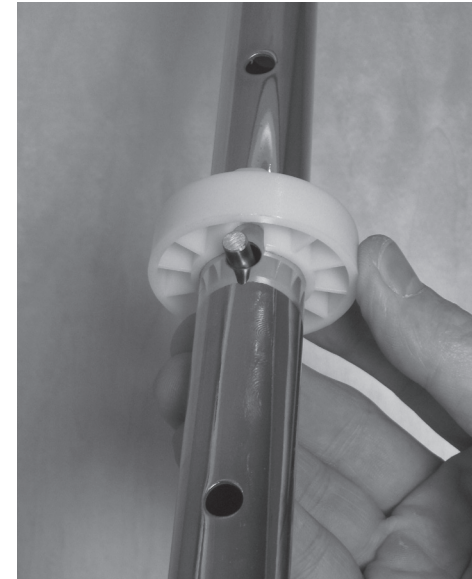

Raise upper shelf and Shelf Support to desired height and press steel pin through the closest hole in the pole. Lower the Shelf Support aligning the pin with the notches as shown.